

Operating and installation instructions

Cooker hood

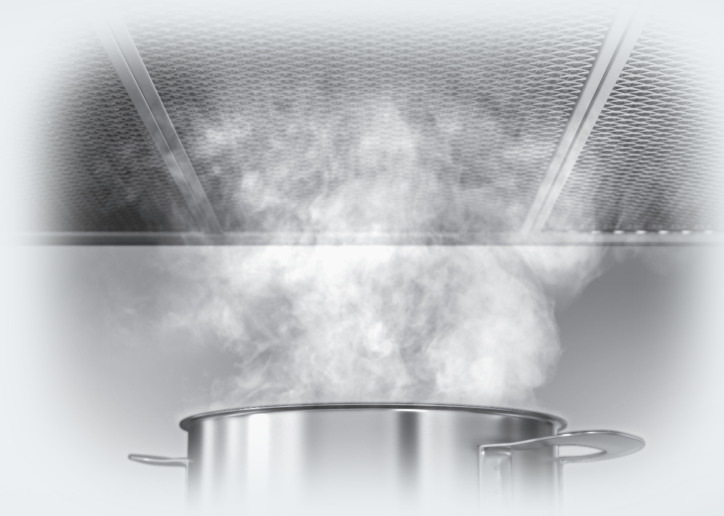

To avoid the risk of accidents or damage to this appliance, it is **essential** to read these instructions before it is installed and used for the first time.

Contents

Warning and Safety instructions	4
Caring for the environment	13
Guide to the appliance	14
Modes of operation	16
Con@ctivity 2.0	17
Operation (Automatic mode)	18
Cooking with the Con@ctivity 2.0 function (Automatic mode)	18
After cooking	19
Leaving automatic mode temporarily	20
Operation (Manual mode)	21
Cooking without the Con@ctivity 2.0 function (Manual mode).	21
To switch the fan on ①	21
To select a power level	21
Run-on option "5 $\frac{1}{2}$ 15"	21
To switch the fan off ①	21
Hob lighting \odot	21
Power management system	22
Operation (Automatic and manual modes)	23
Filter operating hours counter $\otimes\otimes$	23
Sensor tones	25
Cleaning and care	26
Housing	26
Grease filters	27
Resetting the grease filter operating hours counter	28
Fitting and replacing the charcoal filters	29
Resetting the charcoal filter operating hours counter	29
Appliance dimensions	30
Safety distance between hob and cooker hood (S)	31
Installation	33
Installation instructions	33
Protective foil	33
Dismantling	33
Installation accessories	34

Connection for air extraction	36
Condensate trap	37
Silencer	38
Electrical connection	39
Activating the Con@ctivity 2.0 function.	40
Installing the Con@ctivity 2.0 stick.	40
Activating the Con@ctivity 2.0 function on the cooker hood	40
Activating the Con@ctivity 2.0 function on the hob	41
Checking activation	41
Deactivating	42
After Sales Service	43
Technical data	44
Declaration of conformity	44

Warning and Safety instructions

This appliance complies with all relevant safety requirements. Improper use of the appliance can, however, present a risk of both personal injury and damage to property.

To avoid the risk of accidents and damage to the appliance, please read these instructions carefully before installation and before using it for the first time. They contain important information on the safety, installation, use and maintenance of the appliance.

Miele cannot be held liable for damage caused by non-compliance with these Warning and Safety instructions.

Keep these instructions in a safe place and ensure that new users are familiar with the content. Pass them on to any future owner.

Correct application

- ▶ The cooker hood is intended for use in domestic households and similar working and residential environments.
- ▶ The appliance is not intended for outdoor use.
- ▶ It must only be used as a domestic appliance to extract vapours and remove odours from cooking.
- ▶ The appliance must not be used in a non-stationary location (e.g. on a ship).

Warning and Safety instructions

▶ The appliance can only be used by people with reduced physical, sensory or mental capabilities, or lack of experience and knowledge, if they are supervised whilst using it, or have been shown how to use it in a safe way and recognise and understand the consequences of incorrect operation.

Safety with children

▶ Children under 8 years of age must be kept away from the cooker hood unless they are constantly supervised.

▶ Children 8 years and older may use the cooker hood only if they have been shown how to use it in a safe way and understand the hazards involved.

▶ Children must not be allowed to clean or maintain the appliance unsupervised.

▶ Please supervise children in the vicinity of the appliance and do not let them play with it.

▶ Danger of suffocation. Packaging, e.g. plastic wrappings, must be kept out of the reach of babies and children. Whilst playing, children could become entangled in packaging or pull it over their head and suffocate.

Warning and Safety instructions

Technical safety

- ▶ A damaged appliance can be dangerous. Check the appliance for visible signs of damage. Do not use a damaged appliance.
- ▶ The electrical safety of this appliance can only be guaranteed if it is correctly earthed. It is essential that this standard safety requirement is met. If in any doubt please have the electrical installation tested by a qualified electrician.
- ▶ To avoid the risk of damage to the appliance, the connection data (frequency and voltage) on the data plate must correspond to the mains electricity supply. Check that this is the case before connecting the appliance. Consult a qualified electrician if in any doubt.
- ▶ Do not connect the appliance to the mains electrical supply by a multi-socket adapter or extension lead. These are a fire hazard and do not guarantee the required safety of the appliance.
- ▶ For safety reasons, this appliance may only be used when it has been fully installed.
- ▶ Tampering with electrical connections or components and mechanical parts is highly dangerous to the user and can cause operational faults. Only open the housing as described in the instructions given in the installation sheet and in the Cleaning and care section of this booklet. Under no circumstances should any other parts of the housing be opened.
- ▶ Unauthorised installation, maintenance and repairs can cause considerable danger to users. Installation, maintenance and repair work must only be carried out by a Miele authorised technician.

Warning and Safety instructions

- ▶ A damaged connection cable must only be replaced by an approved and suitably qualified technician.
- ▶ Miele can only guarantee the safety of the appliance when original Miele replacement parts are used. Faulty components must only be replaced by genuine Miele original spare parts.
- ▶ During installation, maintenance and repair work, the appliance must be disconnected from the mains electricity supply.

Warning and Safety instructions

Using at the same time as other heating appliances that depend on the air from the room

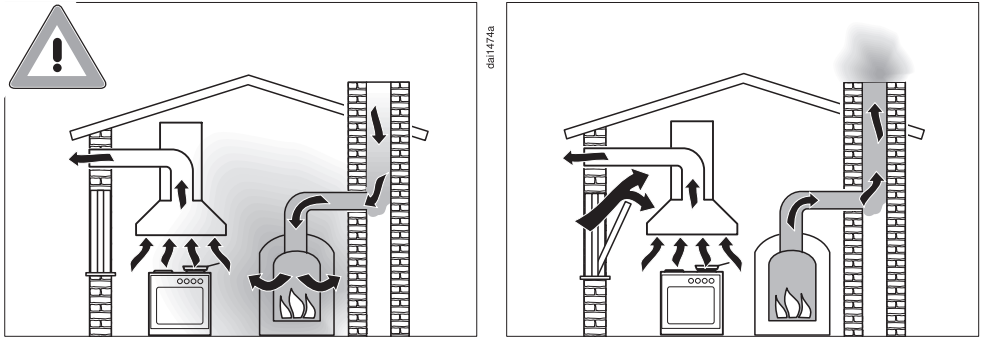

Danger of poisoning by toxic fumes.

► Great care should be taken when using the cooker hood at the same time and in the same room or area of the house as another heating appliance which depends on air in the room.

Such appliances include gas, oil, wood or coal-fired boilers and heaters, continuous flow or other water heaters, gas hobs, cookers or ovens which draw air in from the room and duct exhaust gases out through a chimney or extraction ducting.

Cooker hoods draw air in from the room in which they are installed and from neighbouring rooms. This applies to extraction mode cooker hoods and to recirculation mode cooker hoods with a recirculation box located outside the room. If there is insufficient air, an underpressure will occur. The heating appliance may be starved of oxygen, impairing combustion. Harmful gases could be drawn out of the chimney or extraction ducting back into the room, with potentially fatal consequences.

Warning and Safety instructions

In order to ensure safe operation, and to prevent gases given off by the heating appliances from being drawn back into the room when the cooker hood and the heater are in operation simultaneously, an underpressure of 0.04 mbar (4 pa) is the maximum permissible in the room.

This can be achieved by providing adequate ventilation such as air inlets which cannot be blocked, in windows, doors and outside wall vents, or by other technical measures, such as ensuring that the cooker hood can only be switched on when the heating appliance is switched off or vice versa.

The ventilation must have the appropriate cross-sectional area to ensure an adequate supply of air.

A ventilation brick alone is not generally sufficient to ensure safe ventilation.

 The overall ventilation condition of the dwelling must be taken into account. If in any doubt, the advice of a competent builder or, for gas, a qualified gas fitter (GasSafe registered in the UK) must be sought.

If the hood is being operated in recirculation mode and the air is being directed back into the kitchen, the above restrictions do not apply.

Warning and Safety instructions

Correct use

▶ Danger of burning with open flames. Never use an open flame beneath the cooker hood. To avoid the danger of fire, do not flambé or grill over an open flame. When switched on, the cooker hood could draw flames into the filter. Fat particles sucked into the cooker hood present a fire hazard.

▶ When cooking with a gas hob, a build-up of heat can damage the cooker hood.

- When using the cooker hood over a gas hob, ensure that any burners in use are always covered by a pan. Switch the cooking zone off when a pan is removed, even for a short time.
- Select pans which are suitable for the size of the cooking zone.
- Control the flame so that it does not spread out beyond the sides of the pan.
- Do not allow the pans to overheat excessively (e.g. when using a wok).

▶ Always switch the cooker hood on when using the hob, otherwise condensation may collect in the hood, which could cause corrosion.

▶ Overheated oil and fat can ignite and could set the cooker hood on fire. When cooking with oil or fat, chip pans and deep fat fryers etc, do not leave the pans unattended. Never leave an open grill unattended when grilling.

Warning and Safety instructions

- ▶ Do not use the cooker hood without the filters in place. This way you will avoid the risk of grease and dirt getting into the appliance and hindering its smooth operation.
- ▶ The filters should be regularly cleaned or changed as appropriate. Saturated filters are a fire hazard.
- ▶ The cooker hood can get very hot during cooking due to heat rising from the hob.
Do not touch the housing or the grease filters until the cooker hood has cooled down.
- ▶ Do not use a steam cleaner to clean this appliance. Steam could reach electrical components and cause a short circuit.

Correct installation

- ▶ Check with the manufacturer of your cooking appliance whether it is safe to install a hood above it.
- ▶ The minimum safety distance between the top of the cooker or hob and the bottom of the cooker hood given in the "Appliance dimensions" section of this booklet must be maintained, unless the manufacturer states that a greater safety distance is required. If more than one cooking appliance is fitted beneath the cooker hood, and they have different minimum safety distances to the cooker hood, select the greater distance.
- ▶ Safety regulations prohibit the fitting of a cooker hood over solid fuel stoves.

Warning and Safety instructions

- ▶ All ducting, pipework and fittings must be of non-flammable material. These can be obtained from the Miele Spare Parts department or from builders' merchants.
- ▶ The appliance must not be connected to a chimney or vent flue which is in use. Neither should it be connected to ducting which ventilates rooms with fireplaces.
- ▶ If exhaust air is to be extracted into a chimney or ventilation duct no longer used for other purposes, seek professional advice.

Accessories

- ▶ Only use genuine original Miele accessories with this appliance. Using spare parts or accessories from other manufacturers will invalidate the guarantee, and Miele cannot accept liability.

Disposal of the packing material

The packaging is designed to protect the appliance from damage during transportation. The packaging materials used are selected from materials which are environmentally friendly for disposal, and should be recycled.

Recycling packaging reduces the use of raw materials in the manufacturing process and also reduces the amount of waste in landfill sites.

Packaging e.g. cling film, polystyrene and plastic wrappings must be kept out of the reach of babies and young children. Danger of suffocation!

Disposal of your old appliance

Electrical and electronic appliances often contain valuable materials. They also contain materials which, if handled or disposed of incorrectly, could be potentially hazardous to human health and to the environment. They are, however, essential for the correct functioning of your appliance. Please do not therefore dispose of it with your household waste.

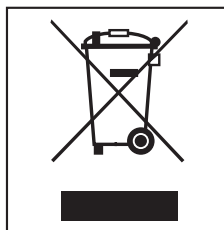

Please dispose of it at your local community waste collection / recycling centre or contact your dealer for advice. Ensure that it presents no danger to children while being stored for disposal.

Guide to the appliance

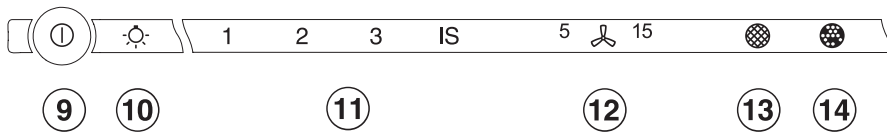
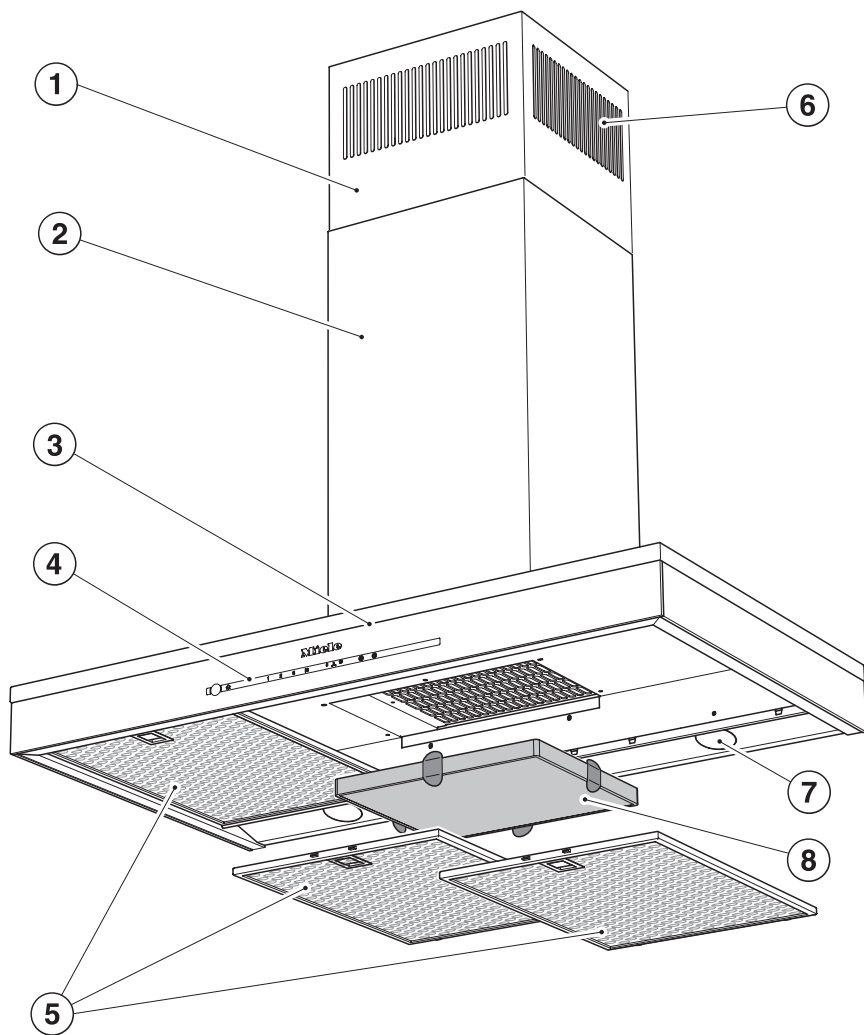

① Extension piece

② Tower

③ Canopy

④ Controls

⑤ Grease filters

⑥ Recirculation grille

(only for recirculation mode)

⑦ Hob lighting

⑧ Charcoal filter

(special accessory for recirculation mode)

⑨ Sensor for switching the fan on and off

⑩ Sensor for the hob lighting

⑪ Sensors for selecting the fan power level

⑫ Sensor for the run-on option

This sensor activates the run-on option. The fan can be set to switch off automatically after either 5 or 15 minutes.

⑬ Sensor for the grease filters

The sensor lights up when the grease filters need to be cleaned.

It is used to reset the operating hours counter every time the grease filters are cleaned (see "Cleaning and care").

It can also be used to check and alter the operating hours counter.

⑭ Sensor for the charcoal filters

The sensor for the charcoal filter lights up when the charcoal filter used in recirculation mode needs to be replaced. For this to happen, the operating hours counter needs to be activated before the appliance is used for the first time.

The sensor is used to reset the operating hours counter every time the charcoal filters are replaced (see "Cleaning and care").

It can also be used to check and alter the operating hours counter.

For information about using the appliance, see "Operation".

Modes of operation

The cooker hood works with

. . . air extraction:

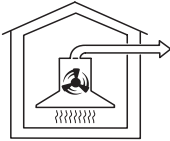

The air is drawn in, cleaned by the grease filters and directed outside.

If the on-site ventilation system does not have a **non-return flap**, then the non-return flap supplied with the appliance must be fitted in the exhaust socket of the motor unit.

Having a non-return flap fitted in the ducting ensures that air, once ducted to the outside, cannot get back into the room again.

The flap is closed when the cooker hood is switched off.

When the cooker hood is switched on, the non-return flap opens for the cooking vapours to be blown directly outside.

. . . air recirculation:

(requires a conversion kit and charcoal filter, available as optional extras: see "Technical Data")



The air is drawn in and cleaned first by the grease filters and then by a **charcoal filter**. The cleaned air is then recirculated back into the kitchen through grilles in the top of the cooker hood extension piece.

Before using the cooker hood in recirculation mode, ensure that the charcoal filter is in place. See "Cleaning and care".

. . . an external motor:

(EXT models only)

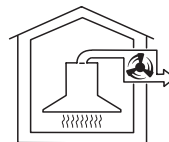

EXT models are designed to be connected to an external motor located outside the room.

The external motor is connected to the cooker hood by means of a control cable, and is operated by the controls on the cooker hood.

Con@ctivity 2.0

Automatic control

This cooker hood is fitted with a communication module which enables the operation of the cooker hood to be automatically controlled by the operating status of a Miele electric hob with onset controls.

The hob transmits information about its operating status to the cooker hood via radio.

- When the hob is switched on, the cooker hood hob lighting switches on and after a short time the cooker hood fan switches on.
- During cooking the cooker hood automatically sets its power level according to the number of cooking zones in operation and their power levels.
- After the hob has been switched off, the cooker hood fan and hob lighting will switch off automatically after a period of time.

For more detailed information about this function, please see "Operation".

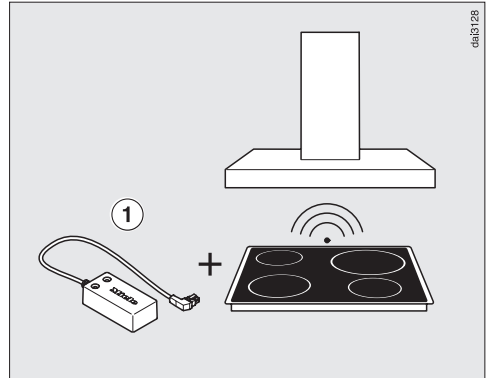

For communication to take place, the hob must be fitted with the Con@ctivity 2.0 stick ①.

The Con@ctivity 2.0 stick for the hob is supplied with this cooker hood. Please refer to the installation instructions for the Con@ctivity 2.0 stick to check whether connection is possible.

To use the Con@ctivity 2.0 function a radio connection between the hob and the cooker hood must be established (see "Activating the Con@ctivity 2.0 function").

Operation (Automatic mode)

When Con@ctivity 2.0 is activated, the cooker hood always operates in automatic mode (see "Activating the Con@ctivity 2.0 function").

To operate the cooker hood manually, see "Cooking without the Con@ctivity 2.0 function".

Cooking with the Con@ctivity 2.0 function (Automatic mode)

- Switch on the hob and select a setting.

The cooker hood lighting will come on.

After a few seconds the fan will come on, first at level **2**, then switching immediately to level **1**.

During cooking the cooker hood automatically sets its power level according to the number of cooking zones in operation and their power levels.

- If a higher setting for a hob cooking zone is selected or more cooking zones are switched on, the hood will then operate at a higher fan power level as well.
- Similarly, if a lower setting is selected for a cooking zone or cooking zones are switched off, the fan power level of the cooker hood will be adjusted accordingly.

The power level is adjusted according to the total number of cooking zones and power settings in use on the hob.

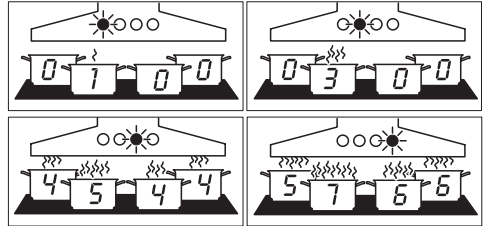

Examples for levels **1** to **4**

Reaction time

The reaction of the cooker hood is slightly delayed because altering the power settings on the hob will not necessarily result in an increase or decrease in cooking vapours.

A delay in the reaction of the cooker hood can also be because the hob transmits information to the cooker hood at intervals.

The cooker hood can react within seconds or a few minutes.

Operation (Automatic mode)

Frying food

- If the hob is switched on at the highest setting and is turned down to a lower setting after approx. 60 to 90 seconds*, a frying process is recognised.
(* 60 seconds to 5 minutes with a HiLight hob).

The cooker hood switches itself on and, when the hob is turned down to a lower setting, switches itself to level **3** and remains at this level for approx. 5 minutes.

After this period, the fan power level is determined by the Con@ctivity 2.0 function.

- You can also manually select another fan power level early if you wish.

After cooking

- When all cooking zones are switched off, the fan power level is reduced in stages within the next few minutes and then eventually switched off. This delay will allow any lingering odours in the air to be neutralised.
 - The fan will reduce immediately from Intensive setting **IS** to level **3**.
 - If it is operating on power level **3** it will switch to power level **2** after approx. 1 minute.
 - From power level **2** it will switch to power level **1** after 2 minutes.
 - Then after 2 minutes operating at power level **1**, the fan will switch off.
 - The lighting will go out 30 seconds later.

The cooking process is complete.

Operation (Automatic mode)

Leaving automatic mode temporarily

- You can also leave automatic mode during cooking, by
 - manually selecting a different fan power level, or
 - manually switching off the cooker hood, or
 - activating the run-on option "5 15" on the cooker hood.
The fan will then switch off after the run-on time selected.
The lighting will remain on.

The cooker hood can now be operated manually (see "Cooking without the Con@ctivity 2.0 function").

- The cooker hood will revert to automatic mode, if
 - after manually selecting a fan power level, you do not operate the cooker hood for approx. 5 minutes.
 - the fan power level you have selected manually is the same as the power level which is selected automatically.
 - the cooker hood fan and the hob are switched off for at least 30 seconds. Automatic mode will start again the next time the hob is switched on.

- If you wish to operate the cooker hood manually for a complete cooking process, switch the cooker hood fan on **before** the hob. If the cooker hood and hob were switched off at least 30 seconds after cooking, automatic mode will resume next time the hob is switched on.

Cooking without the Con@ctivity 2.0 function (Manual mode)

The Con@ctivity 2.0 function must not be activated for this mode.

However, manual operation is temporarily possible even if the Con@ctivity 2.0 function is activated (see "Leaving automatic mode temporarily").

To switch the fan on ①

- Touch the On/Off sensor ①.

The fan will switch on at power level **2**.

To select a power level

Depending on the intensity of the cooking vapours, levels **1** to **3** are usually sufficient for normal cooking.

- Select the level you require by touching the **1**, **2** or **3** sensor.





Intensive setting

- For short periods of cooking food with intensive vapours and a strong aroma, e.g. when searing meat, you may wish to select level **IS**, the Intensive setting.

Run-on option "5 15"

It is advisable to leave the fan running for a few minutes after cooking has finished to neutralise any lingering odours in the air.

The fan can be set to switch off automatically after 5 or 15 minutes.

- After cooking has finished, touch the Run-on option sensor  whilst the fan is still running
 - Touch once = The fan will switch off after 5 minutes (**5**  will light up).
 - Touch twice = The fan will switch off after 15 minutes (**15**  will light up).
- If you touch the Run-on sensor  again, the fan remains on (**5 15** goes out).

To switch the fan off ①

- Touch the On/Off sensor ① to switch the fan off.

Hob lighting

The hob lighting can be switched on and off independently of the fan.

- Touch the hob lighting sensor .

Operation (Manual mode)



Power management system

The cooker hood features a Power management system to help save energy.

The fan power level is reduced and the lighting is switched off automatically.

- If the Intensive setting is selected, the fan will automatically revert to level 3 after 5 minutes, to level 2 after 2 hours and then after a further 30 minutes to level 1. Finally, after a further 30 minutes the fan will switch off.
- If power level 2 or 3 is selected, the fan will revert to a lower setting after 2 hours and then in 30-minute stages until it switches off.
- If level 1 is selected, the fan will switch off after 2 hours.
- The lighting will switch off automatically after 12 hours.

Power management can be deactivated.

- Touch the Run-on sensor  for approx. 10 seconds until the **1** sensor lights up.
- Touch in turn
 - the lighting sensor ,
 - the **1** sensor, and
 - the lighting sensor  again.

If Power management is activated, **1** and **IS** will light up constantly.

- Touch the **1** sensor to deactivate Power management.
1 and **IS** will flash.
Touch **IS** if you want to activate it again.
- Confirm the selection by touching the Run-on sensor .

If you do not confirm within 4 minutes, the cooker hood will automatically revert to the original setting.

Operation (Automatic and manual modes)

Filter operating hours counter

The number of hours the cooker hood has been in operation is stored in memory.

The operating hours counters tell you when the grease filters or charcoal filters need to be cleaned or replaced.

Grease filter operating hours counter

After 30 hours of operation (or another time if the operating hours counter has been altered), the Grease filter sensor  will light up.

The grease filters must then be cleaned and the operating hours counter reset (see "Cleaning and Care").

Altering the grease filter operating hours counter

You can set the operating hours counter to suit the type of cooking you do.



The operating hours counter is set at the factory for 30 hours.

Select a shorter time of 20 hours if you fry a lot.

If you only cook occasionally, we still recommend 20 hours because grease which has built up gradually over a long period of time will harden on the grease filters and make cleaning more difficult.

If you use very little fat for cooking, select a longer time of 40 or 50 hours.

To alter the operating time:

- Touch the On/Off sensor  to switch the fan off.
- Touch the Run-on sensor  and the Grease filter sensor  at the same time.

The Grease filter sensor  and one of the fan power level sensors **1** to **IS** will flash.

Sensors **1** to **IS** indicate the time set:

- Sensor **1** = 20 hours
- Sensor **2** = 30 hours
- Sensor **3** = 40 hours
- Sensor **IS** = 50 hours



- Touch the relevant number to select the time you want.
- Touch the Grease filter sensor  to confirm your selection.

All the indicator lights will go out.

If you do not confirm within 4 minutes, the cooker hood will automatically revert to the original setting.

Checking the grease filter operating hours counter

To check the percentage of time set already used:

- Touch the On/Off sensor  to switch the fan on.
- Touch and hold the grease filter sensor .

Operation (Automatic and manual modes)

One or more of sensors **1** to **IS** will flash.

The number of flashing sensors indicates the percentage of the operating time which has already been used up.

Sensor 1	25 %
Sensor 1 and 2	50 %
Sensor 1 to 3	75 %
Sensor 1 to IS	100 %

- When you take your finger off the Grease filter sensor , the current fan setting will show.

The number of operating hours used remains in the memory, even when the cooker hood is switched off or there is a power cut.

Charcoal filter operating hours counter

(only for recirculation mode)

On delivery, the operating hours counter for the charcoal filter is **deactivated**.



For recirculation mode, the operating hours counter needs to be set to suit the type of cooking you do.

The Charcoal filter sensor  will light up after the cooker hood has operated for the number of hours set.

- The charcoal filter must then be replaced with a new one.

Afterwards, the operating hours counter will need to be reset (see "Cleaning and care").

Activating and altering the charcoal filter operating hours counter

- Touch the On/Off sensor  to switch the fan off.
- Touch the Run-on sensor  and the Charcoal filter sensor  at the same time.

The Grease filter sensor  and one of the fan power level sensors **1** to **IS** will flash.

Sensors **1** to **IS** indicate the time set:
Sensor **1** 120 hours
Sensor **2** 180 hours
Sensor **3** 240 hours
Sensor **IS** Deactivated

- Touch the relevant number to select the time you want.
- Confirm the selection by touching the Charcoal filter sensor .

All the indicator lights will go out.

If you do not confirm within 4 minutes, the cooker hood will automatically revert to the original setting.

Operation (Automatic and manual modes)

Checking the charcoal filter operating hours counter

To check the percentage of time set already used:

- Touch the On/Off sensor ① to switch the fan on.
- Touch and keep your finger on the Charcoal filter sensor ②.

One or more of sensors **1** to **IS** will flash.

The number of flashing sensors indicates the percentage of the operating time which has already been used up.

Sensor 1	25 %
Sensor 1 and 2	50 %
Sensor 1 to 3	75 %
Sensor 1 to IS	100 %

When you take your finger off the Grease filter sensor ③, the current fan setting will show.

The number of operating hours used remains in the memory, even when the cooker hood is switched off or there is a power cut.

Sensor tones

When selecting a function with the sensors, an audible tone will sound briefly to confirm.

The audible tone can be deactivated.

- Touch the On/Off sensor ① to switch the fan off.
- Touch the **IS** sensor and the Grease filter sensor ③ at the same time for approx. 5 seconds until a tone sounds briefly. The audible tone is now switched off for all functions.
- To reactivate the audible tone, repeat the above process.

After the cooker hood has been disconnected from the mains electricity supply or after a power cut, the audible tone is activated regardless of the last setting.

Cleaning and care

 Disconnect the cooker hood from the mains supply before maintenance and care (see "Warning and Safety").

Housing

General

The surfaces and controls are susceptible to scratches and abrasion. Please observe the following cleaning instructions.

- All external surfaces and controls can be cleaned using a microfibre cloth or with warm water and a little washing-up liquid applied with a well wrung-out soft sponge or cloth.
- Wipe the surfaces dry using a soft cloth.
- Glass surfaces can be cleaned with a proprietary cleaning agent for glass.

Avoid:

- cleaning agents containing soda, acids, chlorides or solvents,
- abrasive cleaning agents, e.g. powder cleaners or cream cleaners, and abrasive sponges, as well as pot scourers or sponges which have been previously used with abrasive cleaning agents. These will damage the surface material.
- sharp metal tools,
- oven sprays.

Important for appliances with stainless steel surfaces

Stainless steel surfaces can be cleaned using Miele's non-abrasive cleaning agent for stainless steel, following the instructions on the packaging.

To help prevent re-soiling, Miele conditioning agent for stainless steel can also be used. Follow the instructions on the packaging.

Important for appliances with lacquered housing

Please follow the information given in "General notes" earlier in this section. It is very difficult to clean this type of surface without causing minor marks to the surface material.

This can become particularly noticeable with darker colours and if there is halogen lighting in the kitchen.

Grease filters

The re-usable metal grease filters in the appliance remove solid particles (grease, dust, etc.) from the kitchen vapours, preventing soiling of the cooker hood.

The grease filters should be cleaned regularly (at least every 3-4 weeks) to avoid a build-up of grease, but always clean immediately if the Grease filter sensor  lights up.

Grease which builds up on the grease filters over a long period of time can harden, making cleaning more difficult.

 An oversaturated filter is a fire hazard.

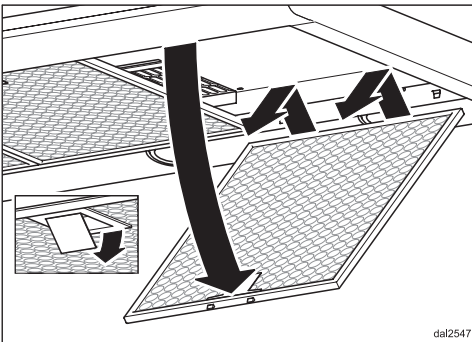

- To take out the grease filters, release the locking clip on the filters, lower the filters 45°, unhook them at the back and remove them.

To avoid damaging the filters or the hob below, make sure you hold the filters securely at all times when handling them.

Cleaning the grease filters by hand

- Clean the filters with a soft nylon brush in a mild solution of hot water and a little washing-up liquid. Do not use "neat" washing-up liquid.

Avoid:

- cleaning agents containing descaling agents,
- powder cleaners, cream cleaners or abrasive all-purpose cleaners.
- oven sprays.

Cleaning the grease filters in the dishwasher

- Place the filters as upright as possible in the lower basket, with the short sides upright, and wash using a 65°C programme, ensuring the spray arm is not obstructed.
- Select a programme with a maximum temperature of 65° C. If a Miele dishwasher is being used, select the Sensor wash programme.
- Use a mild dishwasher detergent.

Depending on the dishwasher detergent used, cleaning the filters in a dishwasher can cause permanent discolouration to the surface. However, this will not affect the functioning of the filters in any way.

Cleaning and care

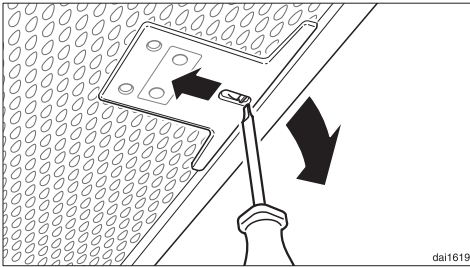

- After cleaning, leave the filters to dry on an absorbent surface before replacing them.
- When removing the filters for cleaning, also clean off any residues of oil or fat from the now accessible housing to prevent the risk of these catching fire.
- Replace the grease filters, making sure that the locking clips are facing down towards the hob.



- If a grease filter is inadvertently replaced upside down, insert a small screwdriver blade into the slit to disengage the clip.

Resetting the grease filter operating hours counter

After cleaning, the operating hours counter needs to be reset.

- Whilst the fan is switched on, touch the Grease filter sensor  for approx. 3 seconds until only the **1** sensor is flashing. The Grease filter sensor  will go out.

If you want to clean the grease filters **before** the operating hours counter has reached its maximum:

- Touch the Grease filter sensor  for approx. 6 seconds until only the **1** sensor is flashing.

Fitting and replacing the charcoal filters

If the cooker hood is connected for recirculation, a charcoal filter must be inserted in addition to the grease filters. This is designed to absorb cooking odours.

It is fitted in the canopy above the grease filters.

New charcoal filters can be purchased from your Miele dealer, from the Miele Spare Parts Department or via the internet at www.miele.shop.com. See back cover for contact details, and "Technical data" for the model number of the filter.

- Before fitting or replacing a charcoal filter, the grease filters must first be taken out (see previous section for instructions on how to do this).

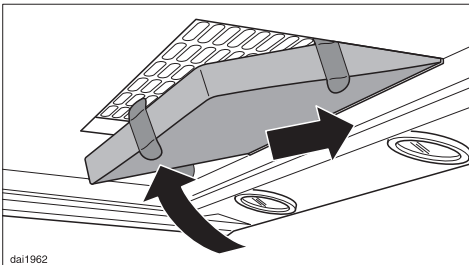

- Remove the charcoal filter from the packaging and place in the recess as shown.
- Replace the grease filters.

When fitting for the first time:

- Activate the operating hours counter (see "Operation").

Always replace the charcoal filter immediately if



- the Charcoal filter sensor  lights up
- or
- it is no longer effective at absorbing kitchen odours.

It should, however, be replaced at least every 6 months.

Used charcoal filters can be disposed of with the normal household waste.

Resetting the charcoal filter operating hours counter

After replacing the charcoal filters, the operating hours counter needs to be reset.

- Whilst the fan is switched on, touch the Charcoal filter sensor  for approx. 3 seconds until only the **1** sensor is flashing. The Charcoal filter sensor  will go out.

If you want to change the charcoal filter **before** the operating hours counter has reached its maximum:

- Touch the Charcoal filter sensor  for approx. 6 seconds until only the **1** sensor is flashing.

Appliance dimensions

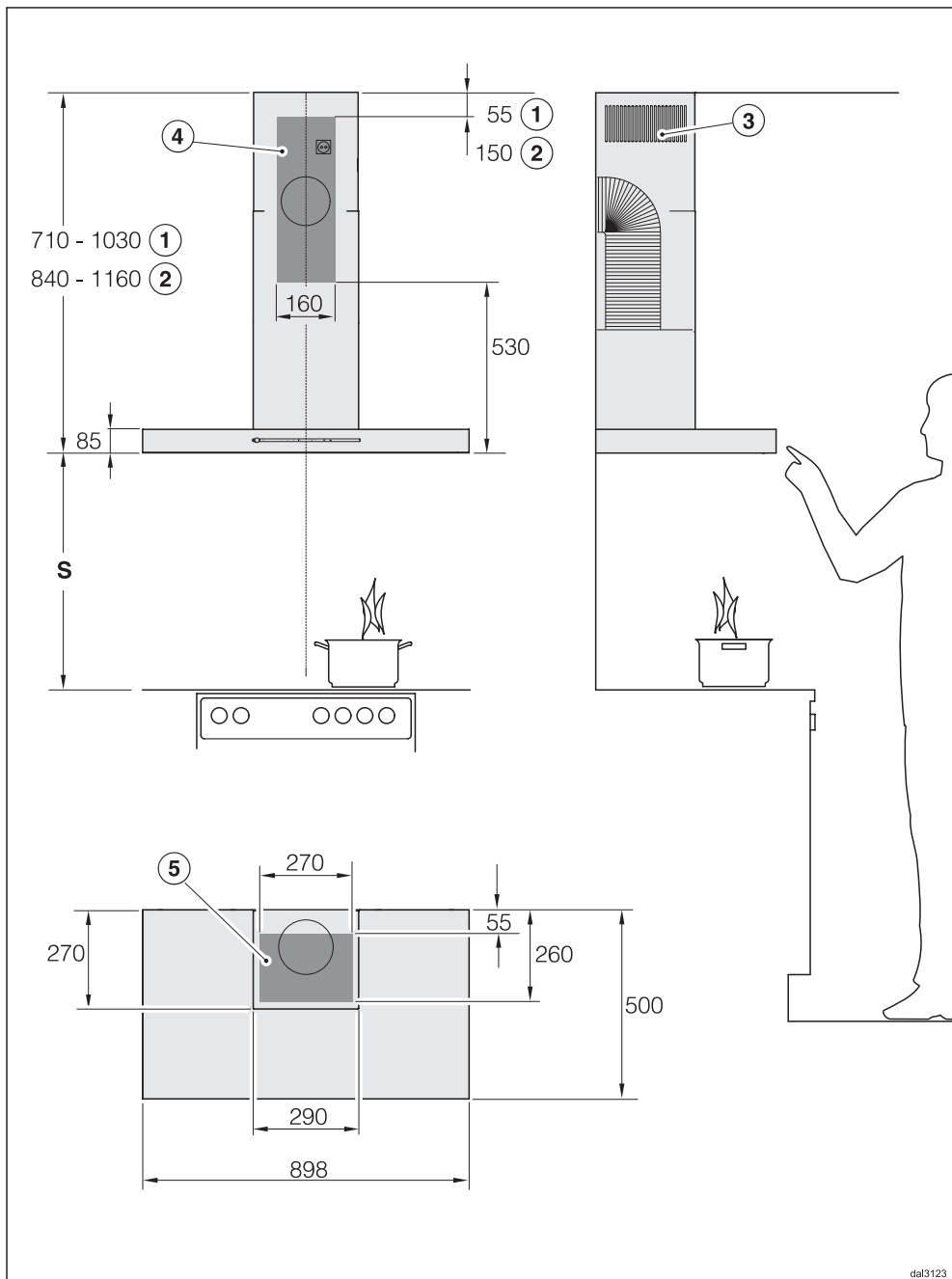

The diagram is not drawn to scale.

Appliance dimensions

- ① Extraction
- ② Recirculation
- ③ Ventilation grill positioned at the top for recirculation

④, ⑤

The shaded areas represent the wall or ceiling area for the vent cut-out and for fitting the connection socket.

For recirculation mode, you only require cut-out area ④ and a connection socket.

Connection for air extraction

Ø 150 mm, or Ø 125 mm with reducing collar.

Safety distance between hob and cooker hood (S)

The following **minimum** safety distance must be maintained between the top of the cooker/hob and the bottom of the cooker hood unless a greater distance is specified by the manufacturer of the cooker or hob:

Cooking appliance	Distance S
Electric hob	450 mm
Open Grill	650 mm
Deep fat fryer (electric)	650 mm
Multi-burner gas hob with a maximum total output of 12.6 kW, no burner exceeding 4.5 kW.	650 mm
Multi-burner gas hob with a total output of more than 12.6 kW, or a multi-burner gas hob where one burner exceeds 4.5 kW.	760 mm
Single gas burner with a maximum output of 6 kW.	650 mm
Single gas burner with output exceeding 6 kW.	760 mm

See "Warning and Safety" instructions for further information.

Appliance dimensions

- When deciding on the safety distance between the hob and cooker hood, please note that a distance of 650 mm above electric cookers/hobs may be preferable to give more working space under the hood.
- Account should also be taken of the height of the person who will be using the hood most often. The person should have sufficient space to work comfortably at the hob, and also be able to reach the hood controls with ease.
- Please be aware that if positioned too high, extraction will be inefficient.
- If you want the top of the cooker hood to be mounted flush with the ceiling, make sure there is adequate space below it for working. See maximum/minimum appliance height.

Drilling diagram

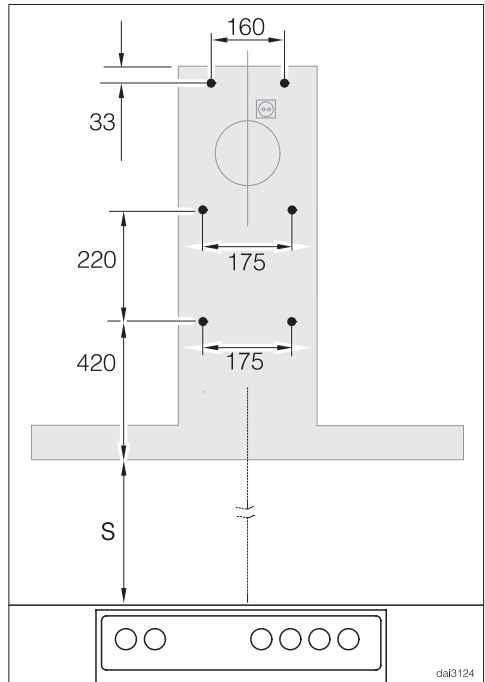

This diagram illustrates where holes for $\text{Ø} 5$ mm screws need to be drilled in the rear wall.

If the cooker hood is being fixed directly to the wall, please follow the directions given in the installation instructions supplied.

Before installation, it is important to read the information given on the following pages as well as the "Appliance dimensions" and the "Warning and safety instructions" at the beginning of this booklet. This is particularly crucial when using the cooker hood at the same time as a heating appliance that relies on oxygen from the same room to avoid the danger of toxic fumes building up.

Installation instructions

See the enclosed Installation sheet for instructions on how to install this appliance.

Protective foil

(on stainless steel appliances)

The housing components have protective foil around them to prevent them being damaged during transport.

Please remove this foil before fitting the housing components. It can be peeled off easily.

Dismantling

Should the appliance ever need to be dismantled, follow the installation instructions in reverse order as described on the installation sheet.

A lever is supplied to assist with the removal of the tower.

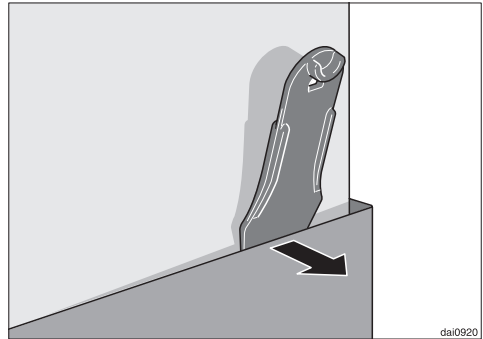

- After loosening the fixing screws on the tower, push the lever between the tower and the extension piece to lever the tower out of its fixings.

Installation

Installation accessories

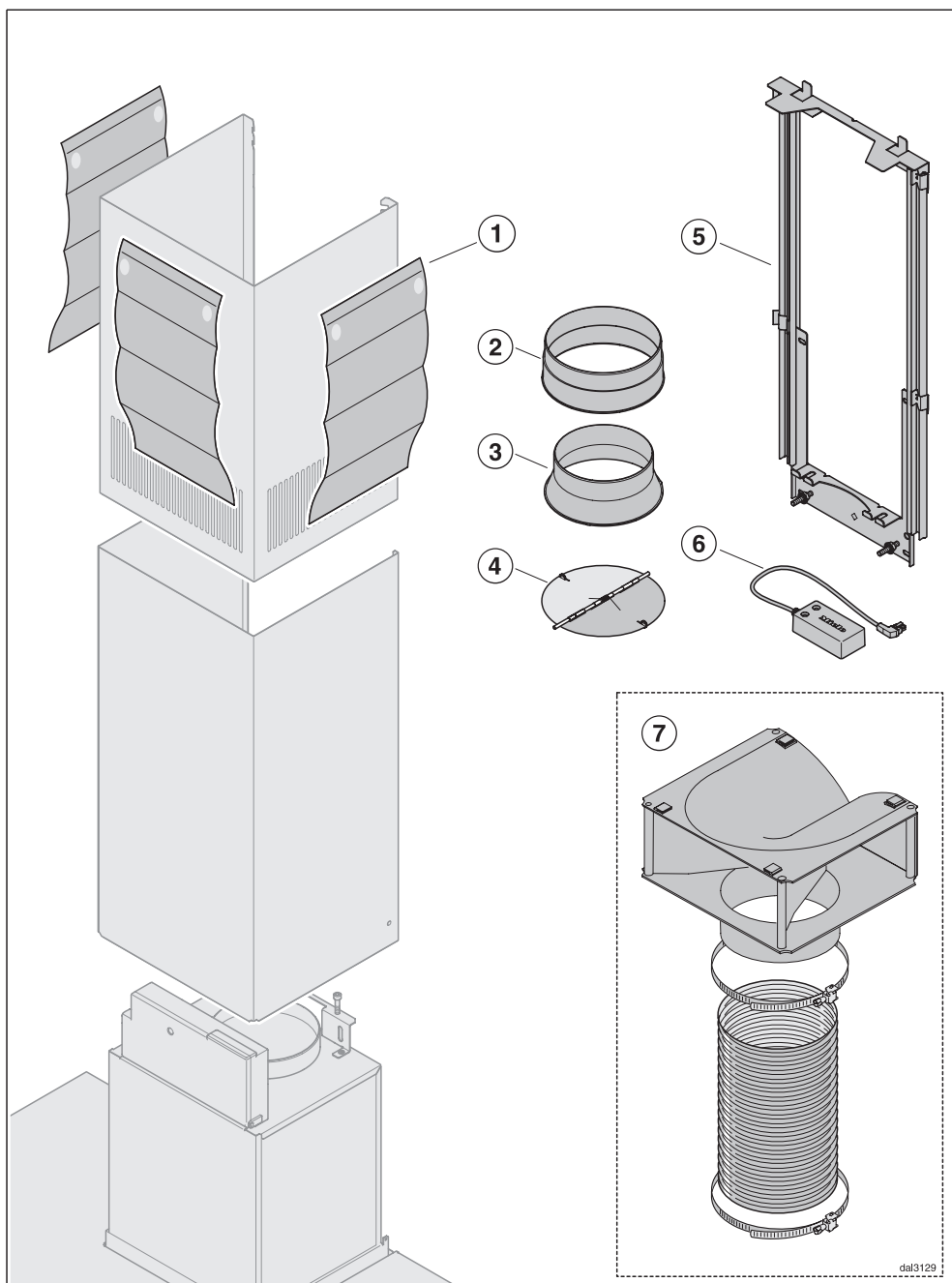

- ① **3 protective sheets**
for use when fitting the tower.
- ② **1 exhaust socket** for exhaust ducting \varnothing 150 mm.
- ③ **1 reducing collar**
for exhaust ducting \varnothing 125 mm.
- ④ **1 non-return valve**
for fitting into the exhaust connection on the motor unit (not for recirculation mode)
- ⑤ **Telescopic wall bracket** for securing the cooker hood to the wall.
- ⑥ **Con@ctivity 2.0 stick**
for retro-fitting the hob
- ⑦ **Conversion kit for recirculation mode**
contains directional unit and flexible aluminium ducting with clips (this kit has to be purchased as an optional extra - see Technical Data).



2 x M 6 self-tapping nuts
for securing the appliance.



2 screws 3.9 x 7.5 mm
for securing the tower.

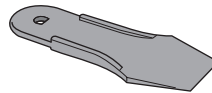

1 lever
for dismantling the tower.

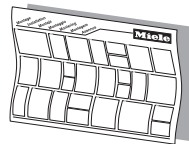

Installation instructions



6 screws 5 x 60 mm and
6 x plugs 8 x 50 mm
for securing the wall bracket.

 The screws and plugs are designed for use in solid walls only. For other types of wall construction, alternative fixings will be required. Make sure that the wall is able to take the weight of the cooker hood.

Connection for air extraction

Important: To avoid the danger of toxic fumes, please observe the Warning and Safety instructions. This is especially crucial when using the cooker hood at the same time as another heating appliance which relies on air from the same room. The cooker hood should be installed according to local and national building regulations. Seek approval from the building inspector where necessary.

- Only use smooth pipes or flexible hoses and fittings made from non-flammable materials for the extraction ducting.
- When using an external motor, make sure that the exhaust ducting is sufficiently rigid. The external motor can cause an underpressure which can result in the exhaust ducting distorting.

To achieve the greatest possible air extraction with the lowest noise level, please note the following:

- To ensure efficient air extraction, the diameter of the exhaust ducting should not be less than 150 mm.
- If flat ducting is being used, the cross-sectional area must not be smaller than the cross-sectional area of the exhaust connection.
- The exhaust ducting should be as short and straight as possible.
- Only use wide radius bends.
- The exhaust ducting should not be kinked or compressed.
- Ensure that all connections are strong and airtight.
- Where ducting is horizontal, it must be laid to slope away at at least 1 cm per metre. This is to ensure that condensate cannot drain back into the cooker hood.

Connection for air extraction

- If the exhaust air is to be ducted into the open air, the installation of a telescopic wall vent or roof vent (available as an optional accessory) is recommended.

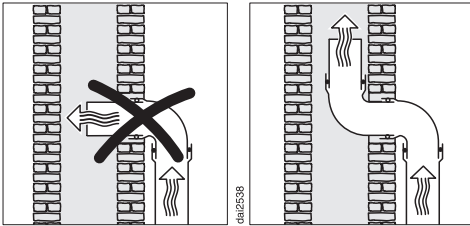

- If the exhaust air is to be ducted into a vent flue, the ducting must be directed in the flow direction of the flue.

Important:

If the exhaust ducting is to run through rooms, ceiling space etc. where there may be great variations in temperature between the different areas, the problem of condensation will need to be addressed. The exhaust ducting will need to be suitably insulated.

Condensate trap

(optional accessory)

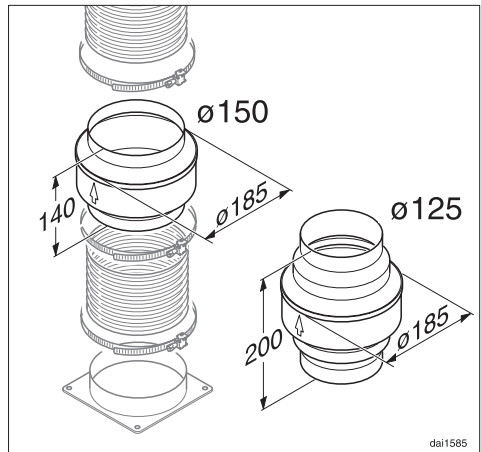

In addition to insulating the exhaust ducting, we recommend that a suitable condensate trap is also installed to collect and evaporate any condensate which may occur. Condensate traps are available for \varnothing 125 mm or \varnothing 150 mm ducting.

When installing a condensate trap, ensure that it is positioned vertically and if possible directly above the exhaust connection. The arrow on the housing indicates the direction of air-flow.

Cooker hoods designed for use with an external motor (...EXT models) have an integrated condensate trap.

Connection for air extraction

Silencer

(optional accessory)

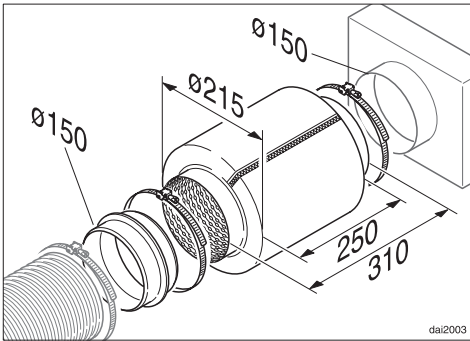

To achieve even further reductions in noise levels, a special system can be fitted in the ducting system.

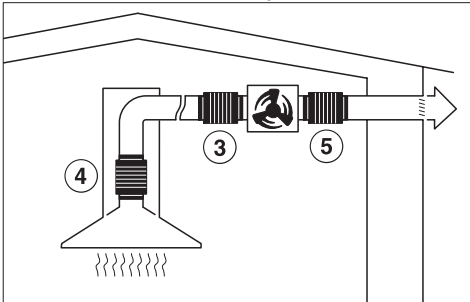
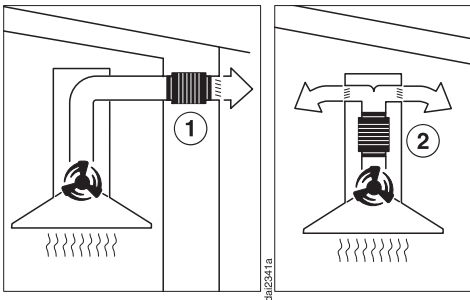

...with air extraction:

The silencer not only reduces noise from the motor outside the house, but also sounds from outside (e.g. traffic noise).

For this reason the silencer must be positioned as close as possible to the ducting exit ①.

...in recirculation mode:

The silencer needs to be positioned between the exhaust connection and the directional unit ②. Ensure there is adequate space in the tower for fitting it.

...air extraction with external motor:

To minimise noise from the motor in the kitchen, the silencer should be positioned in front of the external motor ③ if possible, or if the ducting is long, above the exhaust connection on the cooker hood ④.

In the case of an external motor located inside the house, fitting a silencer behind the external motor ⑤ reduces the noise of the motor outside the house.

In all modes of operation, the most effective noise reductions are achieved if two silencers are fitted one behind the other in the system.

All electrical work should be undertaken by a suitably qualified and competent person in strict accordance with current national and local safety regulations (BS 7671 in the UK).

Installation, repairs and other work by unqualified persons could be dangerous, for which the manufacturer cannot be held liable.

Ensure power is not supplied to the appliance until after installation or repair work has been carried out.

Do not connect the appliance to the mains electricity supply by an extension lead. These do not guarantee the required safety of the appliance.

The connection data is given on the data plate. This is visible when the grease filters have been removed. Ensure that this data matches the household mains supply.

Connection of this appliance should be made via a suitable isolator or a double pole fused spur connection unit which complies with national and local safety regulations and the On-Off switch should be easily accessible after the appliance has been built in. When switched off there must be an all-pole contact gap of 3 mm in the switch (including switch, fuses and relays according to EN 60335).

If the switch is not accessible after installation (depending on country), an additional means of disconnection must be provided for all poles.

For extra safety it is advisable to protect the appliance with a suitable residual current device (RCD). Contact a qualified electrician for advice.

Important

This appliance is supplied for connection to an a.c. 230 V single phase 50 Hz supply.

The wires in the mains lead are coloured in accordance with the following code:

Green/yellow	= earth
Blue	= neutral
Brown	= live

**WARNING:
THIS APPLIANCE MUST BE
EARTHED**

Activating the Con@ctivity 2.0 function

Installing the Con@ctivity 2.0 stick

The hob must be fitted with the Con@ctivity 2.0 stick so that the Con@ctivity 2.0 function can be used. This is supplied with this cooker hood.

- Please refer to the installation instructions for the Con@ctivity 2.0 stick.



The radio connection between the hob and the cooker hood must be activated so that the Con@ctivity 2.0 function can be used.

Both appliances must be installed and operational.

You only need to carry out the activation procedure once. If the appliances are disconnected from the electricity supply, during a power cut for example, they will still remain activated.

Important. To establish the radio connection, the cooker hood and hob are activated at the same time. Start activating the cooker hood first, then the hob.

Activating the Con@ctivity 2.0 function on the cooker hood

- Switch off the fan, hob lighting and hob.
- Touch the Run-on sensor  for approx. 10 seconds until the **1** sensor lights up.
- Touch in turn
 - the **1** sensor,
 - then the **IS** sensor,
 - then the lighting sensor .

If Con@ctivity 2.0 is not activated, **2** and **3** will flash at the same time.

Activating the Con@ctivity 2.0 function

- Touch the **IS** sensor to activate Con@ctivity 2.0.

While it is searching for the radio connection, the **2** sensor will light up and **3** will flash.

- Meanwhile you can start the activation process for the hob.

Activating the Con@ctivity 2.0 function on the hob

- **While** the cooker hood is searching for the radio connection, start the activation process for the hob. For further information please refer to the operating instructions for the hob.

The radio connection is established when sensors **2** and **3** on the cooker hood are constantly lit up.



- Confirm activation of the cooker hood by touching the Run-on option sensor . All the indicator lights will go out.
- Confirm activation of the hob.

The Con@ctivity 2.0 function is now ready for use.

The function will not be activated unless it is confirmed within 4 minutes.

Checking activation

To check whether the Con@ctivity 2.0 function is activated on the cooker hood:

- Switch off the fan and the hob lighting.
- Touch the Run-on sensor  for approx. 10 seconds until the **1** sensor lights up.
- Press in turn
 - the **1** sensor,
 - then the **IS** sensor,
 - then the lighting sensor .

If the Con@ctivity 2.0 function is activated, **2** and **3** will light up constantly.

If the Con@ctivity 2.0 function is not activated, **2** and **3** will flash at the same time.



- Touch the Run-on sensor  to exit the check. All the indicator lights will go out.
- To check whether the hob is activated, please refer to the operating instructions for the hob.

If communication cannot be established even although the cooker hood and the hob have been activated, **both** appliances must be deactivated and then activated again.

Activating the Con@ctivity 2.0 function

Deactivating

To deactivate the cooker hood:

- Switch off the fan, hob lighting and hob.
- Touch the Run-on sensor  for approx. 10 seconds until the **1** sensor lights up.
- Touch in turn
 - the **1** sensor,
 - then the **IS** sensor,
 - then the lighting sensor .

If the Con@ctivity 2.0 function is activated, **2** and **3** will light up constantly.

- Touch the **1** sensor to deactivate Con@ctivity 2.0.

After deactivation has been successfully completed, **2** and **3** will flash simultaneously.

- Confirm deactivation by touching the Run-on sensor . All the indicator lights will go out.
- Deactivate the hob.
For further information please refer to the operating instructions for the hob.

To activate both appliances again, proceed as described previously.

In the event of a fault which you cannot correct yourself, or if the appliance is under guarantee, please contact:

- Your Miele Dealer / Chartered Agent
- or
- The Miele Service Department (see back cover for address).

When contacting your Dealer or Miele, please quote the model and serial number of your appliance. These are shown on the data plate which is visible when the grease filter is removed.

For the U.K.: Please note that telephone calls may be monitored and recorded for training purposes.

N.B. A call-out charge will be applied for service visits where the problem could have been resolved as described in these instructions.

Guarantee

For information on the appliance guarantee specific to your country please contact Miele. See back cover for contact details.

In the U.K. your appliance is guaranteed for 2 years from the date of purchase. However, you must activate your cover by calling 0845 365 6640 or registering online at www.miele.co.uk

Technical data

Total connected load * 99 W
- Fan motor* 90 W
- Hob lighting 3 x 3 W

Voltage AC 230 V

Frequency 50 Hz

Fuse rating 10 A

Electrical cable
length 1.5 m

Weight. 26 kg

Fan performance*

Extraction power according to
EN 61591

Extraction system Ø 150 mm:

Level 1 200 m³/h

Level 2 300 m³/h

Level 3 400 m³/h

IS (Intensive setting) 640 m³/h

Recirculation power with charcoal filter:

Level 1 120 m³/h

Level 2 200 m³/h

Level 3 300 m³/h

IS (Intensive setting) 490 m³/h

Special accessory for recirculation mode:

- Conversion kit DUW 20
- Miele charcoal filter DKF 12-1

* For EXT models, the connected load and extraction power will depend on the type of external motor fitted.

...EXT models:

Length of connection cable to external motor. 1.9 m

Declaration of conformity

Miele hereby declares that the cooker hoods listed on the front of this booklet comply with the basic requirements and other relevant regulations of Guideline 1999/5/EC.

A copy of the complete Declaration of conformity can be obtained from the address on the back page.



United Kingdom

Miele Co. Ltd.
Fairacres, Marcham Road
Abingdon, Oxon, OX14 1TW
Tel: 0845 365 0555
Customer Contact Centre Tel: 0845 365 6600
E-mail: info@miele.co.uk
Internet: www.miele.co.uk

Australia

Miele Australia Pty. Ltd.
ABN 96 005 635 398
1 Gilbert Park Drive, Knoxfield, VIC 3180
Tel: 1300 464 353, Fax: (03) 9764 7149
Internet: www.miele.com.au

China

Miele (Shanghai) Trading Ltd.
1-3 Floor, No. 82 Shi Men Yi Road
Jing' an District
200040 Shanghai, PRC
Tel: +86 21 6157 3500, Fax: +86 21 6157 3511
E-mail: info@miele.cn
Internet: www.miele.cn

Miele (Hong Kong) Limited

41/F - 4101, Manhattan Place
23 Wang Tai Road
Kowloon Bay
Hong Kong
Tel: (852) 2610 1331, Fax: (852) 2610 1013
Email: mielehk@miele.com.hk

India

Miele India Pvt. Ltd.
Ground Floor, Copia Corporate Suites
Plot No. 9, Jasola
New Delhi – 110025
Tel: 011-46 900 000, Fax: 011-46 900 001
E-mail: customercare@miele.in, Internet: www.miele.in

Ireland

Miele Ireland Ltd.
2024 Bianconi Avenue
Citywest Business Campus, Dublin 24
Tel: (01) 461 07 10, Fax: (01) 461 07 97
E-Mail: info@miele.ie, Internet: www.miele.ie

Manufacturer: Miele & Cie. KG

Carl-Miele-Straße 29, 33332 Gütersloh, Germany

Malaysia

Miele Sdn Bhd
Suite 12-2, Level 12
Menara SapuraKencana Petroleum
Solaris Dutamas No. 1, Jalan Dutamas 1
50480 Kuala Lumpur, Malaysia
Phone: +603-6209-0288
Fax: +603-6205-3768

New Zealand

Miele New Zealand Limited
8 College Hill
Freemans Bay, Auckland 1011, NZ
Tel: 0800 264 353, Fax: 0800 463 453
Internet: www.miele.co.nz

Singapore

Miele Southeast Asia
Miele Pte. Ltd.
163 Penang Road
04 - 02/03 Winsland House II
Singapore 238463
Tel: +65 6735 1191, Fax: +65 6735 1161
E-Mail: infosea@miele.com.sg
Internet: www.miele.sg

South Africa

Miele (Pty) Ltd
63 Peter Place, Bryanston 2194
P.O. Box 69434, Bryanston 2021
Tel: (011) 875 9000, Fax: (011) 875 9035
E-mail: info@miele.co.za
Internet: www.miele.co.za

United Arab Emirates

Miele Appliances Ltd.
P.O. Box 11 47 82
Gold & Diamond Park
Sheikh Zayed Road
Building 6 / Offices Nos. 6-214 to 6-220
Dubai
Tel: +971-4-341 84 44
Fax: +971-4-341 88 52
E-Mail: info@miele.ae, Internet: www.miele.ae

DA 6690 W
DA 6690 W EXT